

DISCONNECT SWITCHES

▶ DEFEATABLE DOOR INTERLOCK HANDLES NORTH AMERICAN EDITION

▶ CATALOG 803 ADDENDUM

OUR COMMITMENT MAKES THE DIFFERENCE ▶

BACO[®]

25A / 32A

▶ COMPLETE DISCONNECT SWITCH WITH DEFEATABLE DOOR INTERLOCK HANDLE

PADLOCKABLE PRESENTATION

Yellow/Red Handle
Part Number

Black/Grey Handle
Part Number



0177009LS

25 A

3P
3P + NC/NO
4P neutral on left
4P + NC/NO

0177009LS
0177019LS
0177029LS
0177039LS

0178009LS
0178019LS
0178029LS
0178039LS



0178009LS

32 A

3P
3P + NC/NO
4P neutral on left
4P + NC/NO

0177109LS
0177119LS
0177129LS
0177139LS

0178109LS
0178119LS
0178129LS
0178139LS

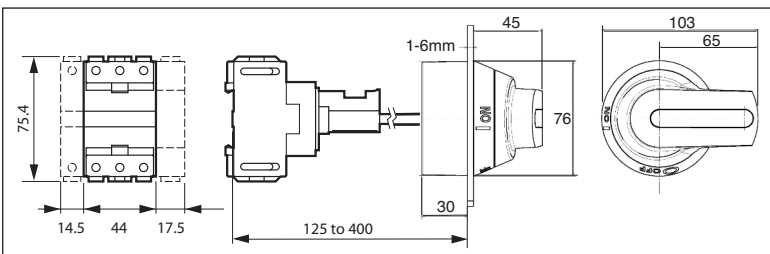

COMPONENTS AND ACCESSORIES

Part Number



0172000

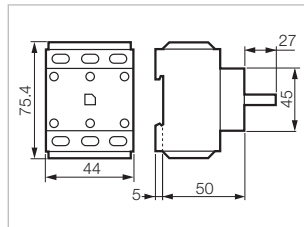

3-pole switch body without handle

25 A
32 A

0172000
0172100

Additional pole

25 A
32 A

0172075
0172175

Neutral pole

25 A
32 A

0172065
0172165

Junction block Ground or Neutral

0172185

Auxiliary contact - 10A

NC/NO

0172179

Defeatable Handle Door Interlock Kits

Yellow/Red
Black/Grey

222277
222278



0172065

0172185

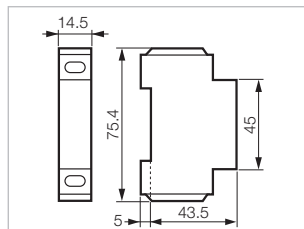

50A / 63A

▶ COMPLETE DISCONNECT SWITCH WITH DEFEATABLE DOOR INTERLOCK HANDLE

PADLOCKABLE PRESENTATION

Yellow/Red Handle
Part Number

Black/Grey Handle
Part Number

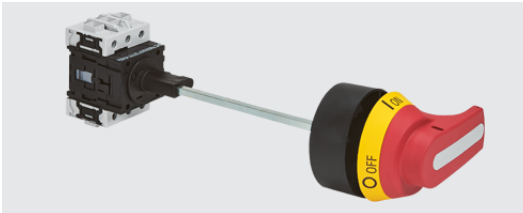

0177209LS

50 A

3P
3P + NC/NO
4P neutral on left
4P + NC/NO

0177209LS
0177219LS
0177229LS
0177239LS

0178209LS
0178219LS
0178229LS
0178239LS

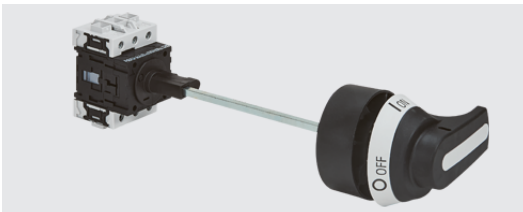

0178209LS

63 A

3P
3P + NC/NO
4P neutral on left
4P + NC/NO

0177309LS
0177319LS
0177329LS
0177339LS

0178309LS
0178319LS
0178329LS
0178339LS

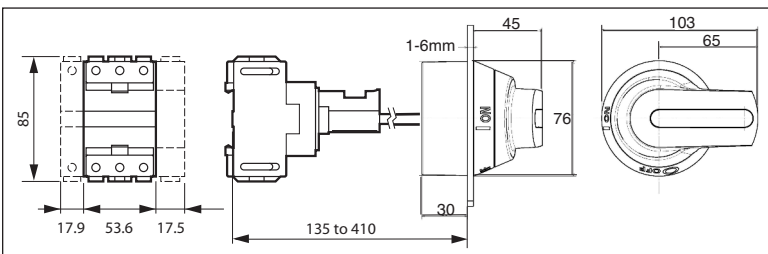

COMPONENTS AND ACCESSORIES

Part Number



0172300

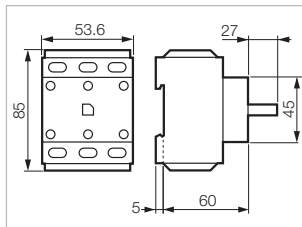

3-pole switch body without handle

50 A
63 A

0172200
0172300

Additional pole

50 A
63 A

0172275
0172375

Neutral pole

50 A
63 A

0172265
0172365

Junction block Ground or Neutral

0172385

Auxiliary contact - 10A

NC/NO

0172179

Defeatable Handle Door Interlock Kits

Yellow/Red
Black/Grey

222277
222278



0172375

0172385

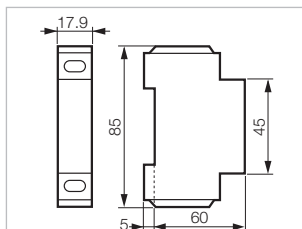

80A / 100A

▶ COMPLETE DISCONNECT SWITCH WITH DEFEATABLE DOOR INTERLOCK HANDLE

PADLOCKABLE PRESENTATION

Yellow/Red Handle
Part Number

Black/Grey Handle
Part Number

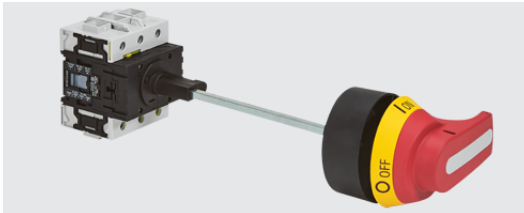

0177409LS

80 A

3P
3P + NC/NO
4P neutral on left
4P + NC/NO

0177409LS
0177419LS
0177429LS
0177439LS

0178409LS
0178419LS
0178429LS
0178439LS

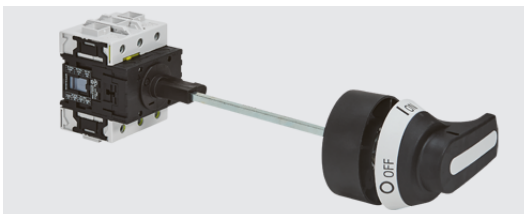

0178409LS

100 A

3P
3P + NC/NO
4P neutral on left
4P + NC/NO

0177509LS
0177519LS
0177529LS
0177539LS

0178509LS
0178519LS
0178529LS
0178539LS

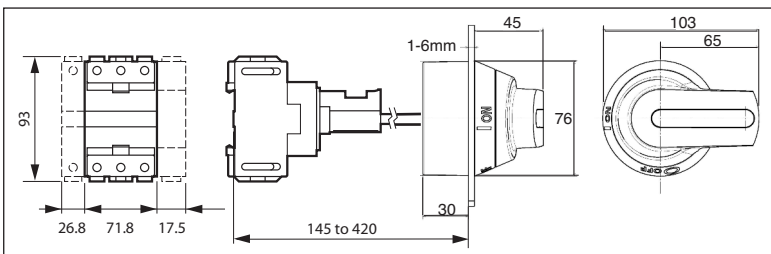

COMPONENTS AND ACCESSORIES

Part Number



0172400

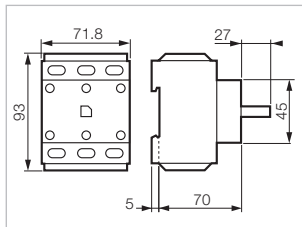

3-pole switch body without handle

80 A
100 A

0172400
0172500

Additional pole

80 A
100 A

0172475
0172575

Neutral pole

80 A
100 A

0172465
0172565

Junction block Ground or Neutral

0172585

Auxiliary contact - 10A

NC/NO

0172179

Defeatable Handle Door Interlock Kits

Yellow/Red
Black/Grey

222277
222278



0172475

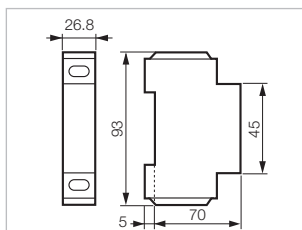

▶ NO/NC AUXILIARY BLOCK

Part Number



0172179

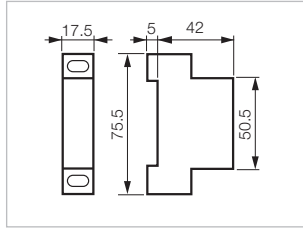

Auxiliary contact - 10A
NC/NO

0172179

▶ DEFEATABLE HANDLE DOOR INTERLOCK KITS



222277



222278

Technical Specifications

▶ GENERAL

Characteristics	25 A	32 A	50 A	63 A	80 A	100 A
▶ Rated voltage (V)	600	600	600	600	600	600
▶ General Use Current (A)	25	32	50	63	80	100
▶ Motor Ratings (hp)						
1 x 120 V	0.75	1	1.5	3	3	5
1 x 240 V	1.5	2	3	5	10	10
1 x 277 V	2	3	5	7.5	10	15
3 x 120 V	1.5	2	3	5	7.5	10
3 x 240 V	3	5	7.5	10	20	25
3 x 480 V	7.5	10	15	20	40	50
3 x 600 V	7.5	10	15	20	40	50
▶ Auxiliary Blocks NO/NC	A600	A600	A600	A600	A600	A600
▶ Wire Guage (AWG)						
3-Pole Body, Additional Pole, Late Break Neutral, Junction Block	8 - 14	8 - 14	4 - 14	4 - 14	1 - 14	1 - 14
Auxiliary Contacts	14 - 18	14 - 18	14 - 18	14 - 18	14 - 18	14 - 18
▶ Short Circuit Rating						
Fuse Type K5 (A)	5000	5000	5000	5000	5000	10000
Fuse Size (A)	40	40	80	80	125	125
Rated break capacity	330	330	800	800	800	800
▶ Mechanical life AC 20 (million)	0.1	0.1	0.04	0.04	0.04	0.04
▶ Operating and Storage temperature	-30°C TO +70 °C , -22°F TO +158°F					
▶ Protection rating	UL/NEMA TYPE 1, 2, 3R, 4, 4X, 12, 12K IP 66					
▶ Conformity to standards	IEC 60697-3 -EN 60 947-3, UL508, CSA22.2, CB Certificate					
▶ Climatic resistance Tropical atmosphere according to	IEC 60068-2-30 Cyclic damp heat					
▶ Padlocks	up to 3 padlocks ø 4 to 8 mm					
▶ Warranty	12 months					

Technical Specifications

► MOUNTING - ASSEMBLY

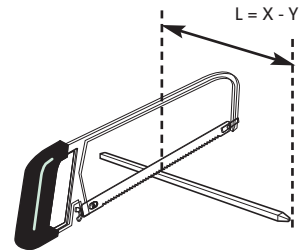
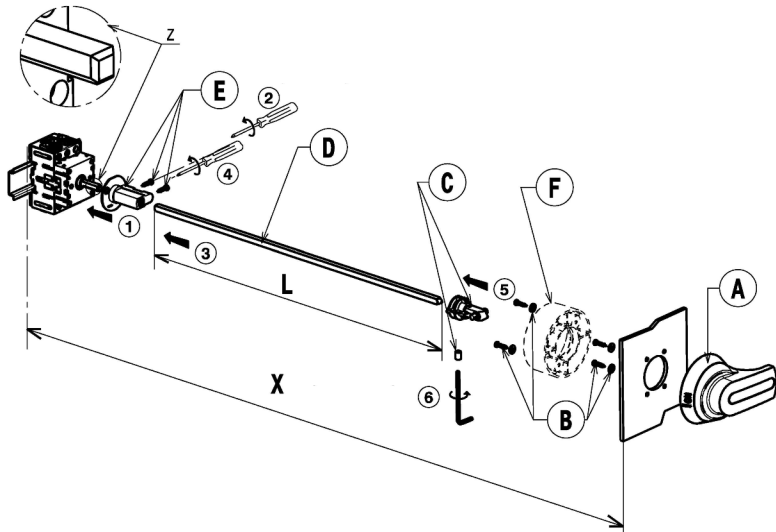

	X	Y
25A / 32A	125 - 400 mm	85 mm
50A / 63A	135 - 410 mm	95 mm
80A / 100A	145 - 420 mm	105 mm

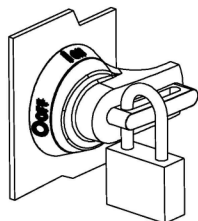
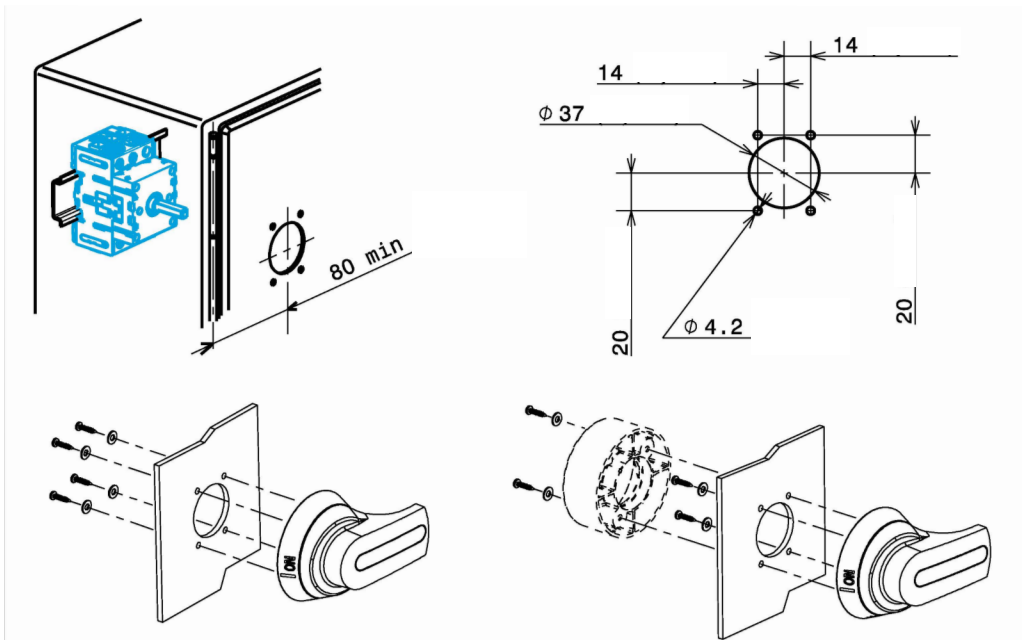

3 Padlocks max. - 4 to 8mm max.

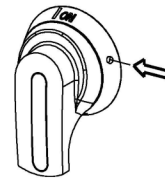

Push with tool to disengage



Pushbuttons

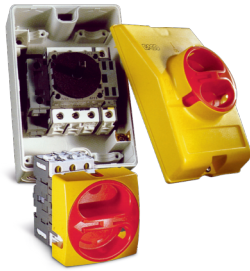

Disconnects



Cam Switches

BACO CONTROLS

www.bacocontrols.com

8431 Loop Rd

Baldwinsville, NY 13027

Tel: 315.635.2500

Fax: 800.356.3981