



▶ **BACO SUPER FLUSH OPERATOR HEADS**

A series of tamper-resistant, 30-mm panel-seal switches

## ▶ A TAMPER-RESISTANT SOLUTION

### ▶ BACO SUPER FLUSH OPERATOR HEADS 30 mm

It is not uncommon for operator heads to be installed in public places, playgrounds, or high-security areas, which has the potential to leave installations with unprotected operator heads vulnerable to vandalism or tampering. One solution to tamper prevention is to utilize a less common fixing type, providing increased security.

Discover the BACO low profile push buttons and pilot lights to cover most industrial applications but not only. Available in metal chrome bezel version, the super flush series of operator heads fit your needs for robustness, safety and simplicity.

These series of operator heads are engineered to meet the stringent demands of applications subjected to harsh use and attempts to damage them.

The LED (L series), the bezel and the button offer a great standard to performance in applications pertaining to anti-vandal issues. Bezels are fabricated from solid zinc alloy with all rounded edges for better safety and flush mounting.

The operator head mounting is also unique and requires 30 mm panel cut-out. The above-panel dimension is 2.8mm inc. gasket while the behind-the-panel body measures 29.6 mm.

This overall product construction is ideal for applications where the need for anti-vandalism, tamper resistance, edge deflection and safety issues are required.

### ▶ DESIGN THAT PROTECTS



### ▶ FEATURES

Zinc alloys called “ZAMAC” has the highest strength and hardness in the zinc, aluminum die casting alloy family. Zinc is natural, infinitely recyclable, and contribute to respect the environment. Bezels receive a chrome surface treatment

▶ **A TAMPER-RESISTANT SOLUTION**

▶ **GREATER PROTECTION**

The BACO series of tamper-resistant, 30mm panel-seal switches are aimed at applications in public locations or where there is a need for greater protection from environmental conditions, such as food or medical equipment and industrial control panels. The BACO series of pushbuttons and pilot lights are offered in both illuminated and non-illuminated models, are flush mountable, and have a low profile.

The dust-tight and splash-proof panel seal design protects this particular BACO series against low pressure jets of water from all directions and meets IP66 of the IEC 60529 standard. In addition, the series has a tamper resistant 23.7 mm actuator with a distinctive long stroke (5.4 mm) and user-friendly actuation.

The switches are available in momentary or maintained action. Terminals are screw or quick connect. Mechanical life is five million operations minimum for momentary circuits, and 500,000 operations minimum for maintained circuits.



▶ **FOOTNOTES**

Security or vandal resistant.  
 Tamper proof bezels installed cannot be removed.

## ▶ A TAMPER-RESISTANT SOLUTION

### ▶ BACO SUPER FLUSH OPERATOR HEADS 30 mm

BACO tamper-resistant series fit applications where electrical switches may be subject to abuse and attempts to damage them.

Manufactured from robust alloy, the resistant BACO super flush series of operator heads are designed for various applications. They offer a high resistance to wear and tear and harsh uses in potentially hostile settings such as public areas, industrial environments and building management applications.

Able to withstand, dust, rain, snow, ice, dirt and moisture, our rugged anti vandal switches are built for tough, demanding applications that may be subject to abuse and damage such as kiosks, elevators, pedestrian crossings and/or machines.

### ▶ TYPICAL APPLICATIONS

- Exposed public areas:  
Ticketing and vending kiosks
- Industrial: Machinery and factory equipment
- Pedestrian cross walks
- Industrial Food Processing Equipment
- Building management: Access control and security systems
- Touristics
- Cleaning industry
- Lifting and moving: elevators and people movers
- Warehouse logistic and a variety of vehicle types
- Medical equipment and Laboratories
- Buildings and structures associated with farming and the agricultural industry
- Water Treatment Plant Room
- Car wash equipment
- Mining industry & much more...



## ▶ APPLICATIONS

Zinc-alloys parts (or Zamak) have mechanical properties close to aluminum. For a wide range of industries and applications. Robust design for superior performance and resilience.

▶ **A TAMPER-RESISTANT SOLUTION**

▶ **TOP-CLASS PRODUCTS**

- Ultra low profile on the front-panel: 2.8mm
- Flush mount: Just 43mm behind the panel (with contact blocks)
- Metallic chrome bezel
- Polycarbonate button plates and lenses
- 30 mm cut-out
- IP66 sealed
- IK05
- Multiple switch functions and colors available
- Combine with separate clip and contact blocks to make complete pushbutton assembly.
- Multiple illumination voltage options



▶ **ROBUSTNESS, SAFETY, SIMPLICITY**

BUTTON: PC - Polycarbonates offers good heat and mechanical resistance. Polycarbonate is a durable material.

BEZEL : die-casting Zamak alloy offer greater impact resistance and wear.

▶ **THE BACO 10-YEAR GUARANTEE**

Baco is committed to a demanding quality charter. That is the reason why BACO products have a 10-year guarantee since September 1st, 2005. You now know you are getting the very best deal on quality switches with a committed brand by your side.



▶ **FEATURES & BENEFITS**

- Low profile, flat button, modern styling.
- Easy to install tamper-proof 30 mm mounting base.
- Total dust ingress. Protected from watering from any direction.

▶ **TECHNICAL CHARACTERISTICS**

▶ **PRODUCT FEATURES**

**MECHANICAL OPERATION**

---

Mechanical endurance in million cycles is :

5,000,000 operations minimum for spring-return  
 500,000 operations minimum for stay-put

**ELECTRICAL RATINGS**

---

6A @ 120VAC, 3A @ 240VAC, or 1,5A @ 24VDC for power models; and 24VAC/DC, 130VA, 230VAC for Led models.

Gold-plated silver contacts available for low voltages and currents.

**DURABILITY**

---

Electrical operation is 1,000,000 cycles minimum

LED pilot lights endurance is :

100,000 hours minimum at 25°C for red and yellow LEDs.  
 50,000 hours minimum at 25°C for white, green and blue LEDs:

▶ **INSTALLATION PRINCIPLE**

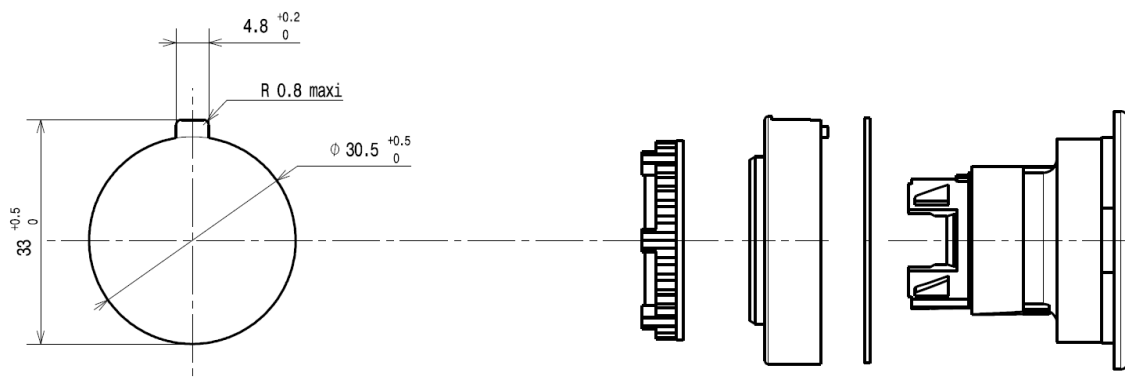

*BACO super flush buttons requires a specific 30 mm cut out on the panel to be mounted.*

▶ **ADVANTAGES**

Long service life: > five million cycles of mechanical operation  
 Locking lever removable contact blocks  
 Modular construction for maximum flexibility

▶ **CONFORMING TO STANDARDS**

IEC EN 60947-1  
 UL 508  
 UL-CSA approved

VARIETY OF DEVICES AND OPTIONS

▶ SPRING RETURN – SUPER FLUSH – NON ILLUMINATED

Cat. No.

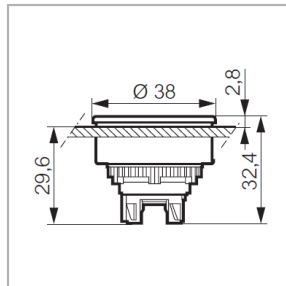

Metallic chrome bezel  
Cut-out 30 mm

**Without engraving**

● Red	L23AA01
● Green	L23AA02
● Black	L23AA03
● Yellow	L23AA04
○ White	L23AA05
● Blue	L23AA06

**With engraving**

⊙ Red	L23AA81
● Green	L23AA82

**On demand engraving**

*Symbol code to be added at the end*

● Red	L23AA31_  _
● Green	L23AA32_  _
● Black	L23AA33_  _
● Yellow	L23AA34_  _
○ White	L23AA35_  _
● Blue	L23AA36_  _

▶ FOOTNOTES

Excellent tactile feedback  
Standard text or symbol ISO/DIN  
Custom graphics available

5.4-mm operator travel for pushbuttons ensures comfortable and reliable operation  
Actuation force: 5N

VARIETY OF DEVICES AND OPTIONS

▶ STAY PUT – SUPER FLUSH – NON ILLUMINATED

Cat. No.

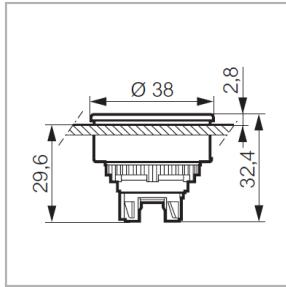

Metallic chrome bezel  
Cut-out 30 mm

**Without engraving**

● Red	L23CA01
● Green	L23CA02
● Black	L23CA03
● Yellow	L23CA04
○ White	L23CA05
● Blue	L23CA06

**On demand engraving**

*Symbol code to be added at the end*

● Red	L23CA31_  _
● Green	L23CA32_  _
● Black	L23CA33_  _
● Yellow	L23CA34_  _
○ White	L23CA35_  _
● Blue	L23CA36_  _

▶ **FOOTNOTES**

Operating temperature: -25°C to 70°C  
Cold test according to IEC 600682-1 standard

Dry heat test according to IEC 60068-2-2 standard  
Constant humidity test according to IEC 60068-2-3 standard



VARIETY OF DEVICES AND OPTIONS

▶ SPRING RETURN – SUPER FLUSH – ILLUMINATED

Cat. No.

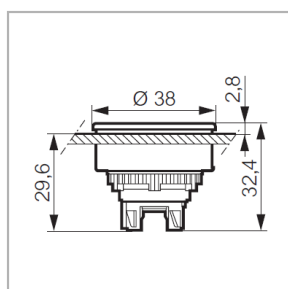

Metallic chrome bezel  
Cut-out 30 mm

**Without engraving**

● Red	L23AH10
● Green	L23AH20
● Yellow	L23AH40
○ White	L23AH50
● Blue	L23AH60

**On demand engraving**

*Symbol code to be added at the end*

● Red	L23AH31_ _ _
● Green	L23AH32_ _ _
● Yellow	L23AH34_ _ _
○ White	L23AH35_ _ _
● Blue	L23AH36_ _ _

▶ STAY PUT – SUPER FLUSH

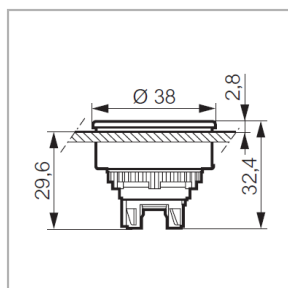

● Red	L23CH10
● Green	L23CH20
● Yellow	L23CH40
○ White	L23CH50
● Blue	L23CH60

▶ FOOTNOTES

LED illumination

Available assembled or as sub-components

Worldwide approvals: UL listed, CSA, CCC certified, and CE.

VARIETY OF DEVICES AND OPTIONS

▶ **PILOT LIGHTS – SUPER FLUSH – ILLUMINATED**

Cat. No.

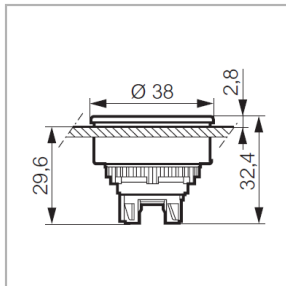

Metallic chrome bezel  
Cut-out 30 mm  
To be combined with a clip and LED Block

**Without engraving**

● Red	L23SE10
● Green	L23SE20
● Yellow	L23SE40
○ White	L23SE50
● Blue	L23SE60

**On demand engraving**

*Symbol code to be added at the end*

● Red	L23SE31_  _
● Green	L23SE32_  _
● Yellow	L23SE34_  _
○ White	L23SE35_  _
● Blue	L23SE36_  _

▶ **FIXING TOOL**

Cat. No.



Fixing tool for locking ring

LWA0234

▶ **FOOTNOTES**











Panel thickness: 1-6 mm

Tightening torque: 3 Nm or tightened with fixing tool LWA0234 to hand tight after pressure point plus another half turn.

## SYMBOLS FOR HEADS

## ▶ STANDARD SYMBOLS ISO/DIN

Cat. No.

	Continuous straight-line movement ISO 1	A01
	Alternating straight-line movement ISO 5	A05
	Continuous rotating movement clockwise ISO 7 – DIN 100	A07
	Continuous rotating mov. anti-clockwise ISO 7B	B07
	Forward ISO 16	A16
	Increase in value ISO 28	A28
	Decrease in value ISO 29	A29
	Adjustable ISO 62	A62
	Clamp, block apply pressure ISO 63A	A63
	Clamp, block apply pressure ISO 63B	B63











## ▶ FOOTNOTES

Optional symbol code to be added at the end of the catalog number  
2 marking colors available: black, white.

## SYMBOLS FOR HEADS

### ▶ STANDARD SYMBOLS ISO/DIN

Cat. No.

	Unclamp, release ISO 64A	A64
	Unclamp, release ISO 64B	B64
	Brake ISO 65	A65
	Release brake ISO 66	A66
	Automatic cycle (or semi-automatic) ISO 67	A67
	Manual control ISO 68	A68
	"ON" close circuit ISO 69	A69
	"STOP" close circuit ISO 70	A70
	ON/OFF close + open circuit ISO 71	A71
	Close circuit manual impulse ISO 72	A72
	Clutch ISO 74 – DIN 46	A74

### ▶ FOOTNOTES

Optional symbol code to be added at the end of the catalog number

Customize the color, typography, pictogram or import your image and create a unique product for your machine

## SYMBOLS FOR HEADS

## ▶ ADDITIONAL STANDARD SYMBOLS

Cat. No.



B01



E01



F01



B62



E62



F62



003



004



005

## ▶ CUSTOMIZED ENGRAVINGS

Please consult us for the creation of your customized engravings  
Optional text can be also added please enquire for more details.

## ▶ FOOTNOTES

Optional symbol code to be added at the end of the catalog number

Pad printing or tampoo-printing offers great resolution

Discover our range of products in our online catalog at: <http://www.bacocontrols.com>



[www.bacocontrols.com](http://www.bacocontrols.com)